



IQS227AS/B DATASHEET

Single channel capacitive proximity
and touch controller

The **IQS227AS/B** ProxSense® IC is a fully integrated Self Capacitive sensor with dual outputs (Touch and Proximity outputs).

Features

- > Sub 2.5µA in Low Power Mode while sensing Proximity
- > **Automatic Tuning Implementation (ATI)** - Automatic tuning of sense electrode
- > **Internal Capacitor Implementation (ICI)** – reference capacitor on-chip
- > Supply voltage: 1.8V to 3.6V
- > Minimum external components
- > Data streaming option
- > Advanced on-chip digital signal processing
- > User selectable (OTP):
 - 4 Power Modes
 - IO sink / source
 - Time-out for stuck key
 - Output mode (Direct / Latch / Toggle)
 - Proximity and Touch Button sensitivity

RoHS2
Compliant



Applications

- > LCD, Plasma & LED TVs
- > GSM cellular telephones – On ear detection / touch keys
- > LED flashlights or headlamps
- > White goods and appliances
- > Office equipment, toys, sanitary ware
- > Flame proof, hazardous environment Human Interface Devices
- > Proximity detection enables backlighting activation
- > Wake-up from standby applications
- > Replacement for electromechanical switches
- > Find-In-The-Dark (FITD) applications
- > Automotive: Door pocket lighting, electric window control
- > GUI trigger on Proximity detected.

Available options

T _A	TSOT23-6	WLCSP-8	DFN-6
-20°C to 85°C	IQS227AS	-	-
-40°C to 85°C	IQS227B	IQS227B	IQS227B



Contents

IQS227AS/B DATASHEET	1
1 OVERVIEW	5
1.1 APPLICABILITY	5
1.2 ANALOGUE FUNCTIONALITY	5
2 PACKAGING AND PIN-OUT	6
2.1 IQS227AS/B.....	6
2.1.1 TSOT23-6 Pin-out	6
2.1.2 WLCSP-8 Pin-out.....	7
2.1.3 DFN-6 Pin-out	8
2.2 SCHEMATIC.....	9
2.2.1 TSOT23-6.....	9
2.2.2 WLCSP-8.....	9
2.2.3 DFN-6.....	10
3 USER CONFIGURABLE OPTIONS	11
3.1 CONFIGURING OF DEVICES	11
4 MEASURING CAPACITANCE USING THE CHARGE TRANSFER METHOD	14
5 DESCRIPTIONS OF USER OPTIONS	14
5.1 PROXIMITY / TOUCH SENSOR.....	15
5.2 LOGIC SELECT FOR OUTPUTS	15
5.3 OUTPUT PIN FUNCTION	15
5.3.1 Output function: Active	15
5.3.2 Output function: Latch (for t_{LATCH}).....	15
5.3.3 Output function: Toggle.....	16
5.4 PROXIMITY THRESHOLD	16
5.5 TOUCH THRESHOLD	16
5.6 POWER MODES.....	17
5.7 BASE VALUES	18
5.8 MULTIPLIERS	18
5.9 CHARGE TRANSFER	18
5.10 ATI TARGET COUNTS.....	18
5.11 NOISE DETECT.....	18
5.12 ENABLE PARTIAL ATI	18
5.13 FILTERS USED BY THE IQS227AS/B	18
5.13.1 Long Term Average (LTA)	18
5.13.2 IIR Raw Data filter	19
6 DATA STREAMING MODE	19
6.1 EVENT MODE	21
6.2 I ² C	21
7 AUTO TUNING IMPLEMENTATION (ATI)	21
7.1 AUTOMATIC ATI	21
7.2 IQS227AS/B NOISE IMMUNITY.....	22
8 ELECTRICAL SPECIFICATIONS	23
8.1 ABSOLUTE MAXIMUM SPECIFICATIONS	23
8.2 GENERAL CHARACTERISTICS	23



8.3 OUTPUT CHARACTERISTICS	24
8.4 PACKAGING INFORMATION	25
8.4.1 TSOT23-6.....	25
8.4.2 WLCSP-8.....	26
8.4.3 DFN-6.....	27
8.5 PACKAGE MSL	28
9 DATASHEET AND PART-NUMBER INFORMATION	29
9.1 ORDERING INFORMATION.....	29
9.2 DEVICE MARKING – TOP	30
9.2.1 TSOT23-6 Packaging Markings	30
9.2.2 WLCSP-8 Package Markings.....	31
9.2.3 DFN-6 Package Markings	31
9.3 DEVICE MARKING - BOTTOM.....	31
9.4 TAPE & REEL SPECIFICATION	32
APPENDIX A. MEMORY MAP	33
APPENDIX B. CONTACT INFORMATION	37



List of Abbreviations

ATI	Automatic Tuning Implementation
BP	Boost Power Mode
CS	Counts (Number of Charge Transfers)
C _s	Internal Reference Capacitor
EMI	Electromagnetic Interference
ESD	Electro-Static Discharge
FTB/EFT	(Electrical) Fast Transient Bursts
GND	Ground
HC	Halt Charge
LP	Low Power Mode
LTA	Long Term Average
ND	Noise Detect
THR	Threshold



1 Overview

The IQS227AS/B is a single channel capacitive proximity and touch controller with an internal voltage regular and reference capacitor (C_s).

The IQS227AS/B devices have dedicated pin(s) for the connection of sense electrodes (C_x) and output pins for proximity events on POUT and touch event on TOUT. The output pins can be configured for various output methods including a serial data streaming option on TOUT (1-wire protocol) or debug I²C.

Device configuration is determined by one time programmable (OTP) options.

The devices automatically track slow varying environmental changes via various filters,

detect noise and has an Automatic Tuning Implementation (ATI) to tune the device sense electrode(s). The IQS227AS/B is built on ProxSense® new low voltage platform ideal for battery application (down to 1.8V).

1.1 Applicability

All specifications, except where specifically mentioned otherwise, provided by this datasheet are applicable to the following ranges:

- > Temperature:
 - IQS227AS: -20°C to +85°C
 - IQS227B: -40°C to +85°C
- > Supply voltage (V_{DDHI}): 1.8V to 3.6V

1.2 Analogue Functionality

The analogue circuitry measures the capacitance of a sense electrode attached to the C_x pin through a charge transfer process that is periodically initiated by the digital circuitry. The measuring process is referred to a conversion and consists of the discharging of reference capacitor and C_x , the charging of C_x and then a series of charge transfers from C_x to C_s until a trip voltage is reached. The number of charge transfers required to reach the trip voltage is referred to as the Counts (CS).

The capacitance measurement circuitry makes use of an internal C_s and voltage reference (V_{REF}).

The analogue circuitry further provides functionality for:

- > Power on reset (POR) detection.
- > Reset detection.
- > Detection of a watch dog timer (WDT)



2 Packaging and Pin-out

2.1 IQS227AS/B

The IQS227AS is available in a TSOT23-6 package, the IQS227B is available in TSOT23-6 or WLCSP-8 package

2.1.1 TSOT23-6 Pin-out

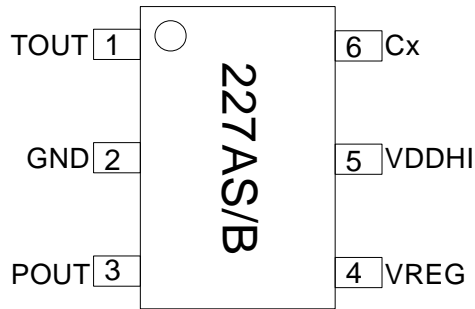

Figure 2.1: Pin-out of IQS227AS/B in TSOT23-6 package.

Table 2.1: Pin-out description.

IQS227AS/B			
Pin	Name	Type	Function
1	TOUT	Digital Out	Touch Output
2	GND	Ground	GND Reference
3	POUT	Digital Out	Proximity Output
4	VREG	Analogue Output	Internal Regulator Pin
5	VDDHI	Supply Input	Supply Voltage Input
6	CX	Analogue I/O	Sense Electrode



2.1.2 WLCSP-8 Pin-out

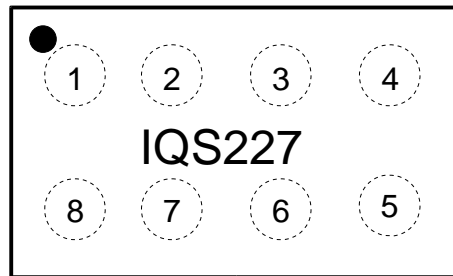

Figure 2.2 IQS227B 8-pin WLCSP

Table 2.2 8 -pin WLCSP Pin-out Description

IQS227B 8-pin WLCSP			
Pin	Name	Type	Function
1	Cx	Sense electrode	Connect to conductive area intended for sensor
2	TOUT	Digital Out	Touch Output
3	VREG	Regulator output	Requires external capacitor
4	VSS	Signal GND	
5	INPUT	Digital Input	Floating input during runtime. Recommended: Connect to POUT
6	POUT	Digital Out	Proximity Output
7	VDDHI	Supply Input	Supply Voltage Input
8	PGM	Configuration pin	Connection for OTP programming. Floating input during runtime. Recommended: Connect to TOUT pin. Programming can still be performed using this pin, provided a diode is used. (See AZD026 – Configuration Tools Overview)



2.1.3 DFN-6 Pin-out

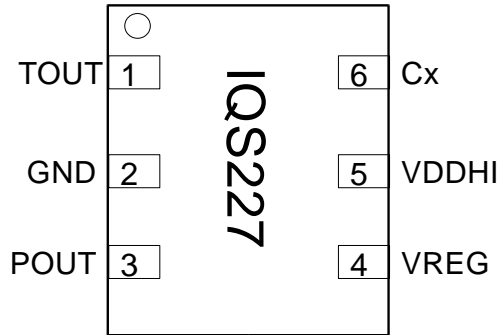

Figure 2.3: Pin-out of IQS227B in DFN-6 package.

Table 2.3: Pin-out description.

IQS227B 6-pin DFN			
Pin	Name	Type	Function
1	TOUT	Digital Out	Touch Output
2	GND	Ground	GND Reference
3	POUT	Digital Out	Proximity Output
4	VREG	Analogue Output	Internal Regulator Pin
5	VDDHI	Supply Input	Supply Voltage Input
6	CX	Analogue I/O	Sense Electrode



2.2 Schematic

2.2.1 TSOT23-6

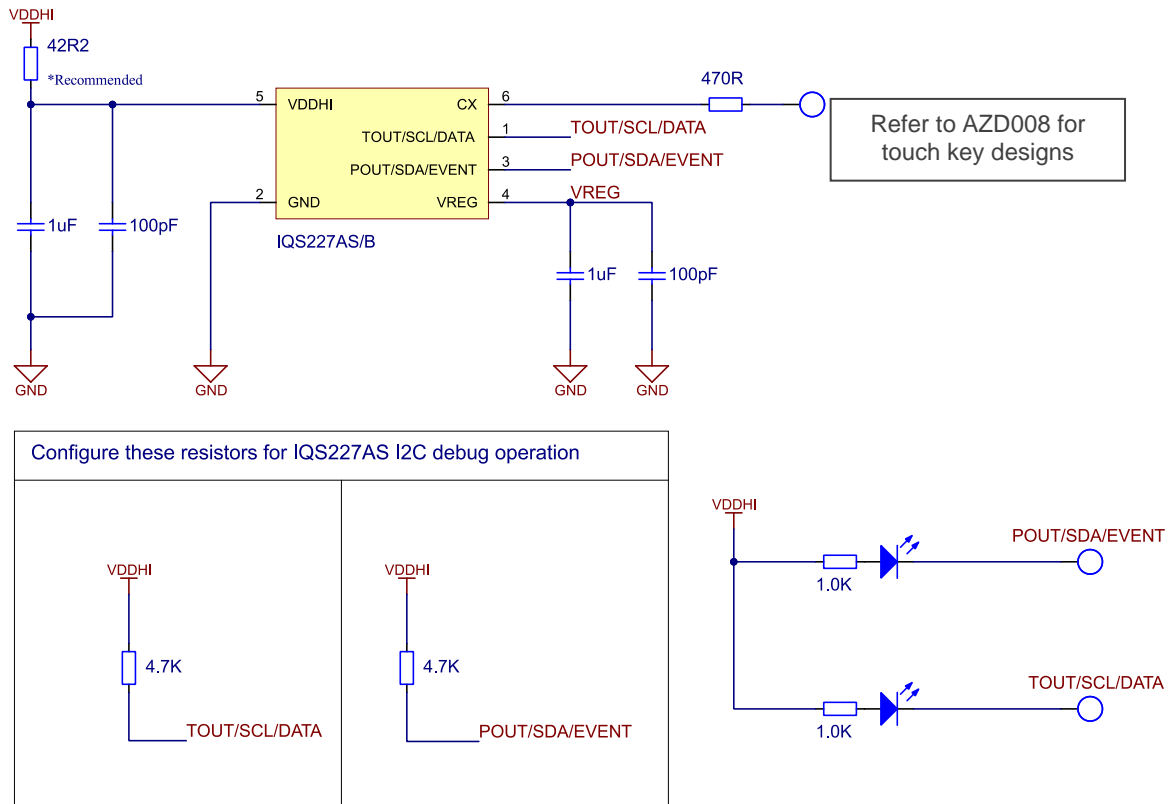

Figure 2.4: Typical application schematic of IQS227AS/B. 100pF capacitors are optional for added RF immunity. Place all decoupling capacitors (on VDDHI and VREG) as close to the IC as possible.

Where a system level ESD strike is found to cause the IC to go into ESD induced latch-up, it is suggested that the supply current to the IQS227 IC is limited by means of a series resistor that could limit the maximum supply current to the IC to <80mA.

2.2.2 WLCSP-8

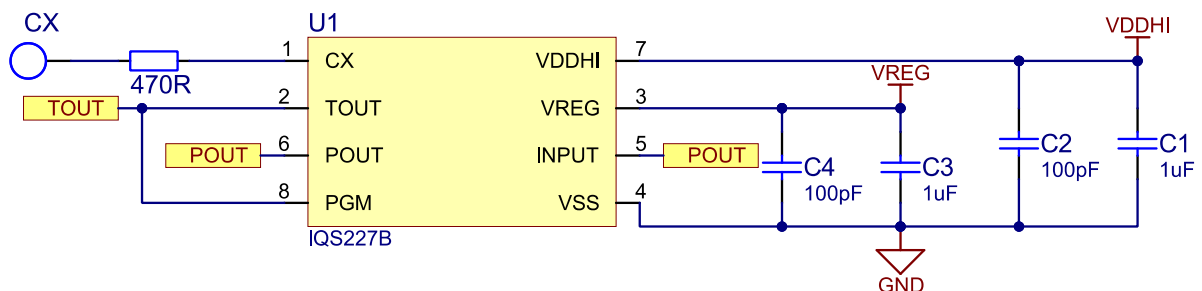

Figure 2.5 Typical application reference schematic of IQS227B WLCSP-8 Package. C2 & C3 are optional for added RF immunity



2.2.3 DFN-6

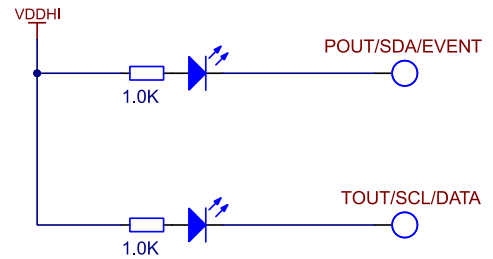
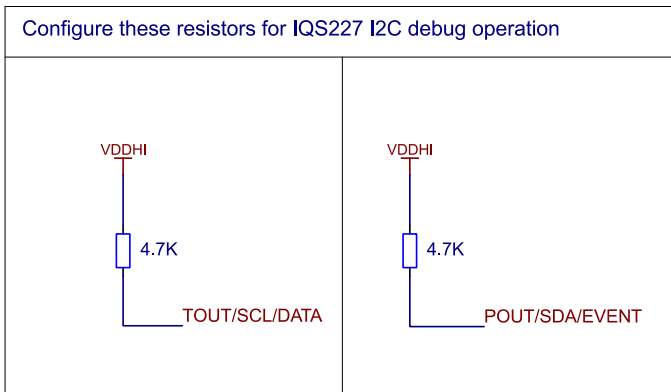
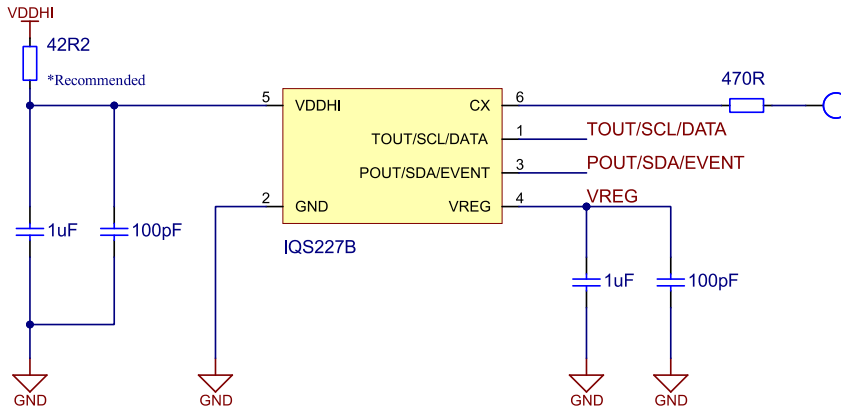

Figure 2.6 Typical application reference schematic of IQS227B DFN-6 Package. C2 & C3 are optional for added RF immunity



3 User Configurable Options

The IQS227AS/B provides One Time Programmable (OTP) user options (each option can be modified only once). The device is fully functional in the default state. OTP options are intended for specific applications.

The configuration of the device can be done on packaged devices or in-circuit. In-circuit configuration may be limited by values of external components chosen.

A number of standard device configurations are available. Azoteq can supply pre-configured devices for large quantities.

3.1 Configuring of Devices

Azoteq offers a Configuration Tool (CT210) and accompanying software (USBProg.exe) that can be used to program the OTP user options for prototyping purposes. More details regarding the configuration of the device with the USBProg program is explained by application note: “AZD007 – USBProg Overview” which can be found on the Azoteq website.

Alternate programming solutions of the IQS227AS/B also exist. For further enquiries regarding this matter please contact Azoteq at ProxSenseSupport@azoteq.com or the local distributor

Table 3.1: User Selectable Configuration Options: Bank 0 (0xC4H)

T _{FUNC}	P _{FUNC}	LOGIC	T _{THR2}	T _{THR1}	T _{THR0}	P _{THR1}	P _{THR1}
bit 7							bit 0
Bank0: bit 7	T _{FUNC} : Touch Function 0 = Normal 1 = Toggle			Section 5.3			
Bank0: bit 6	P _{FUNC} : Proximity Function 0 = Normal 1 = Latch			Section 5.3			
Bank0: bit 5	LOGIC: I/O's Output Logic Select 0 = Active Low 1 = Active High			Section 5.2			
Bank0: bit 4-2	T _{THR} : Touch Thresholds 000 = 72/256 001 = 8/256 010 = 24/256 011 = 48/256 100 = 96/256 101 = 128/256 110 = 160/256 111 = 192/256			Section 5.5			
Bank0: bit 1-0	P _{THR} : Proximity Thresholds 00 = 4 01 = 2 10 = 8 11 = 16			Section 5.4			



Table 3.2: : User Selectable Configuration Options: Bank 1 – Full ATI (0xC5H)

t _{HALT1}	t _{HALT0}	~	~	~	BASE ₂	BASE ₁	BASE ₀
bit 7					bit 0		
Bank1: bit 7-6		t _{HALT} : Halt times 00 = 20 seconds 01 = 40 seconds 10 = Never 11 = Always (Prox on 40s)			Section 5.13		
Bank1: bit 5-3		Not used					
Bank1: bit 2-0		BASE: Base Value 000 = 200 001 = 50 010 = 75 011 = 100 100 = 150 101 = 250 110 = 300 111 = 500			Section 5.7		

Table 3.3: User Selectable Configuration Options: Bank 1 – Partial ATI

t _{HALT1}	t _{HALT0}	MULT _{SENSE1}	MULT _{SENSE0}	MULT _{COMP3}	MULT _{COMP2}	MULT _{COMP1}	MULT _{COMP0}
bit 7					bit 0		
Bank1:7-6		t _{HALT} : Halt times 00 = 20 seconds 01 = 40 seconds 10 = Never 11 = Always (Prox on 40s)			Section 5.13		
Bank1: bit 5-4		MULT: Multiplier for Sensitivity 00 = 1 01 = 2 10 = 3 11 = 4			Section 5.8		
Bank1: bit 3-0		MULT: Multiplier for Compensation 0000 = 0 1111 = 15			Section 5.8		



Table 3.4: User Selectable Configuration Options: Bank 2 (0xC6H)

STREAM	TRANS	COMMS	ND	Target	ATI	LP1	LP0
bit 7							
Bank2: bit 7	STREAM: Streaming Method 0 = 1-wire 1 = 2-wire (I ² C)			Section 6.2			
Bank2: bit 6	TRANS: Charge Transfer Frequency 0 = 512kHz 1 = 250kHz			Section 5.9			
Bank2: bit 5	COMMS: Streaming 0 = Disabled 1 = Enabled			Section 6			
Bank2: bit 4	ND: Noise Detect 0 = Disabled 1 = Enabled (1-wire comms only)			Section 5.11			
Bank2: bit 3	Target: ATI target counts 0 = 1024 1 = 512			Section 5.10			
Bank2: bit 2	ATI: ATI selection 0 = Full 1 = Partial			Section 5.12			
Bank2: bit 1-0	LP: Low Power Modes 00 = BP (9ms) 01 = NP (128ms) 10 = LP1 (256ms) 11 = LP2 (512ms)			Section 5.6			
bit 0							



4 Measuring capacitance using the *Charge Transfer* method

The *charge transfer* method of capacitive sensing is employed on the IQS227AS/B.

A charge cycle is used to take a measurement of the capacitance of the sense electrode (connected to Cx) relative to ground. It consists of a series of pulses charging Cx and discharging Cx to the reference capacitor, at the charge transfer frequency (FCX - refer to Section 8). The number of the pulses required to reach a trip voltage on the reference capacitor is referred to as **Count Value** (CS) which is the instantaneous capacitive measurement. The Counts (CS) are used to determine if either a physical contact or proximity event occurred (refer to section 5.13.1), based on the change in Counts (CS) detected. The typical values of CS, without a touch or proximity condition range between 650 and 1150 Counts, although higher and lower counts can be used based on the application requirements. With counts larger than +/-1150

the gain of the system may become too high causing unsteady operation.

The IQS227AS/B schedules a charge cycle every t_{SAMPLE} seconds to ensure regular samples for processing of results. The duration of the charge cycle is defined as t_{CHARGE} . (refer to 0) and varies according to the counts required to reach the trip voltage. Following the charge cycle other activities such as data streaming is completed (if in streaming mode), before the next charge cycle is initiated.

Please note: Attaching a probe to the Cx pin will increase the capacitance of the sense plate and therefore C_s . This may have an immediate influence on the counts (decrease t_{CHARGE}) and cause a proximity or touch event. After t_{HALT} seconds the system will adjust to accommodate for this change. If the total load on Cx, with the probe attached is still lower than the maximum Cx load the system will continue to function normally after t_{HALT} seconds with the probe attached.

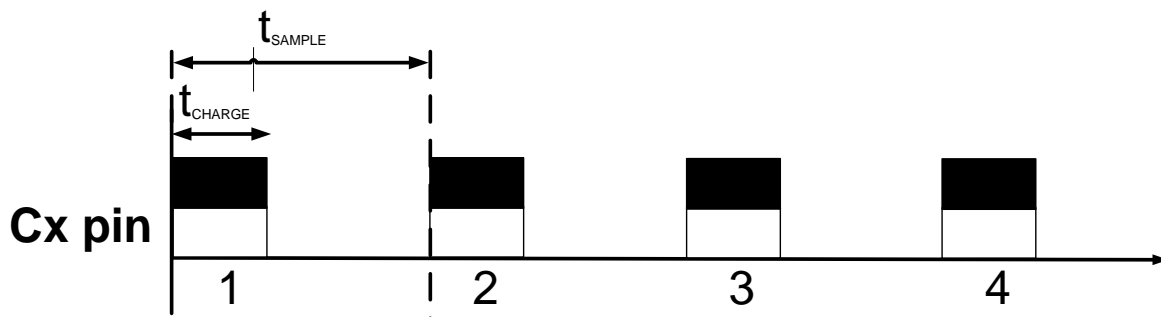

Figure 4.1: Charge cycles as can be seen on Cx.

5 Descriptions of User Options

This section describes the individual user programmable options of the IQS227AS/B in more detail.

User programmable options are programmed to One Time Programmable (OTP) fuse registers (refer to Section 3).

- > HIGH=Logical '1' and LOW=Logical '0'.
- > The following sections are explained with POUT and TOUT taken as 'Active LOW'.
- > The default is always where bits are set to 0.

Refer to section 0 for the sourcing and sinking capabilities POUT and TOUT. These pins are sourced from V_{DDHI} and will be turned HIGH (when active high) for a minimum time of t_{HIGH} , and LOW for a minimum time of t_{LOW} (when active low).

Note:



5.1 Proximity / Touch Sensor

The IQS227AS/B provides a Proximity output on POUT and a Touch output on TOUT, and does not need to be configured.

5.2 Logic select for outputs

The logic used by the device can be selected as active HIGH or active LOW. The output pins, POUT and TOUT, will function based on this selection. The I/O's are push pull in both directions and does not require a pull-up resistor. When configured as Active High, the I/O's will remain high at POR until ATI has been completed. ATI times will vary based on the capacitive load on the sensor, but typically do not exceed 500ms.

Configuration: Bank0 bit5

LOGIC: Output logic select -

Bit	Selection
0	Active Low
1	Active High

5.3 Output pin function

Various options for the function of the output pin(s) are available. These are selected as follow:

Configuration: Bank0 bit7-6

FUNC1:FUNC0 OUTPUT Pins' functions

Bit	Selection
00	POUT active, TOUT active
01	POUT latch, TOUT active
10	POUT active, TOUT toggle
11	POUT latch, TOUT toggle

5.3.1 Output function: Active

With a Proximity or Touch event, the output pin will change to LOW and stay LOW for as long as the event remains (see Figure 5.1 Also refer to the use of t_{HALT} section 5.13.1 that may cause the termination of the event.

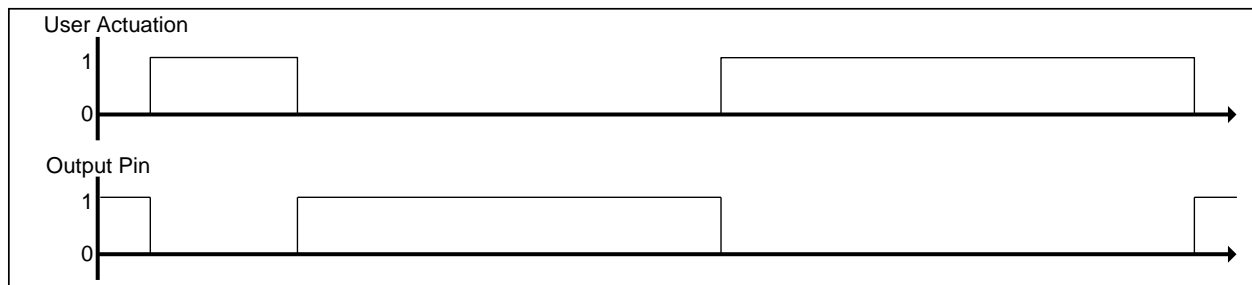

Figure 5.1: Active Mode Output Configuration

5.3.2 Output function: Latch (for t_{LATCH})

With a Proximity or Touch event, the output pin will latch LOW for t_{LATCH} seconds (4 seconds).

When the event terminates prior to t_{LATCH} the output pin will remain LOW.

When the event remains active longer than t_{LATCH} the output pin will remain LOW as long as the event remains active (see Figure 5.2)

When a subsequent event is made before the latch time (4 seconds) has passed, the timer will reset and the output will remain low for another duration of t_{LATCH} seconds (4 seconds). For more details see Figure 5.2.

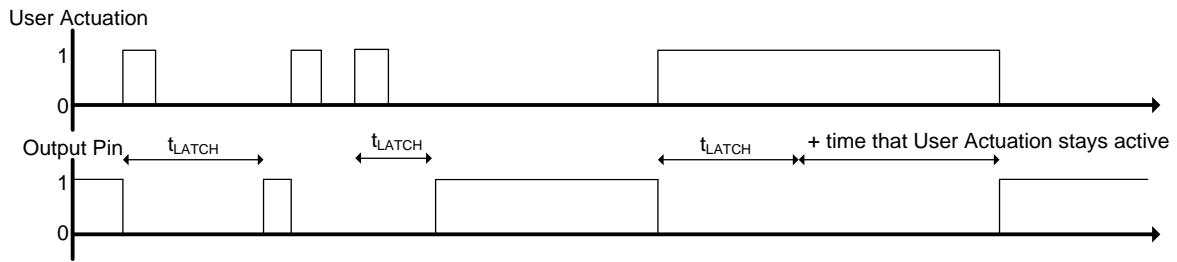

Figure 5.2: Latch Mode Output Configuration

5.3.3 Output function: Toggle

The output pin will toggle with every Proximity or Touch event occurring. Thus when an event

occurs and the output is LOW the output will become HIGH and when the output is HIGH the output will become LOW (see Figure 5.3)

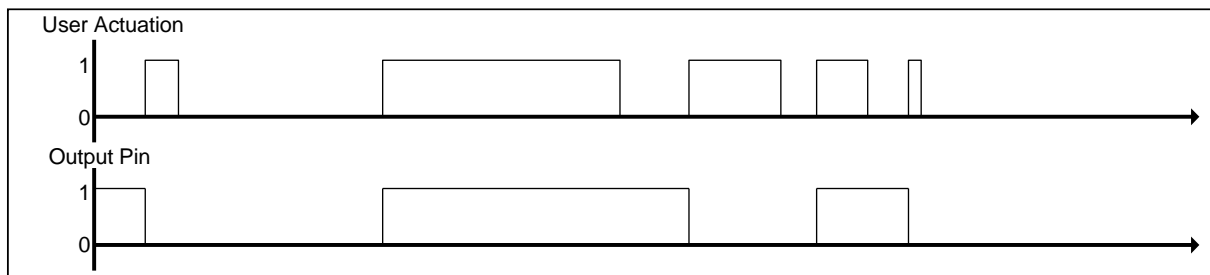

Figure 5.3: Toggle Mode Output Configuration

5.4 Proximity Threshold

The IQS227AS/B has 4 proximity threshold settings. The proximity threshold is selected by the designer to obtain the desired sensitivity and noise immunity. The proximity event is triggered based on the selected proximity threshold; the Counts (CS) and the LTA (Long Term Average). The threshold is expressed in terms of counts; the same as CS (refer to 5)

$$P_{THR} \leq LTA - CS$$

Where LTA is the Long Term Average (refer to 5.13.1)

5.5 Touch Threshold

The IQS227AS/B has 8 touch threshold settings. The touch threshold is selected by the designer to obtain the desired touch sensitivity. The touch threshold is expressed as a fraction of the LTA as follows:

$$T_{THR} = \frac{x}{256} \times LTA$$

The touch event is triggered based on T_{TH} , Counts (CS) and LTA. A touch event is

Configuration: Bank0 bit1-0

P_{THR1}:P_{THR0} Proximity Thresholds

Bit	Selection
00	4
01	2 (Most sensitive)
10	8
11	16 (Least sensitive)

A proximity event is identified when for at least 6 consecutive samples the following equation holds:

identified when for at least 3 consecutive samples the following equation holds:

$$T_{THR} \leq LTA - CS$$

With lower average counts (therefore lower LTA) values the touch threshold will be lower and vice versa.



Configuration: Bank0 bit4-2

T _{THR2} :T _{THR0} : Touch Thresholds	
Bit	Selection
000	72/256
001	8/256 (Most sensitive)
010	24/256
011	48/256
100	96/256
101	128/256
110	160/256
111	192/256 (Least sensitive)

5.6 Power Modes

The IQS227AS/B has four power modes specifically designed to reduce current consumption for battery applications.

The power modes are basically implemented around the occurrence of charge cycle every t_{SAMPLE} seconds (refer to Table 5.1). The fewer charge transfer cycles that need to occur per second the lower the [power consumption](#) (but decreased response time).

During Boost Power Mode (BP), charge cycles are initiated approximately every 9ms.

While in any power mode the device will zoom to BP whenever an existing count sample (CS) indicates a possible proximity or touch event. The device will remain in BP for t_{ZOOM} seconds and then return to the selected power mode. The Zoom function allows reliable detection of events with counts being produced at the BP rate.

Table 5.1: Power Mode configuration: Bank2 bit1-0

Bit	Power Mode timing	t _{SAMPLE} (ms)
00	t _{BP} (default)	BP (9ms)
01	t _{NP}	128
10	t _{LP1}	256
11	t _{LP2}	512

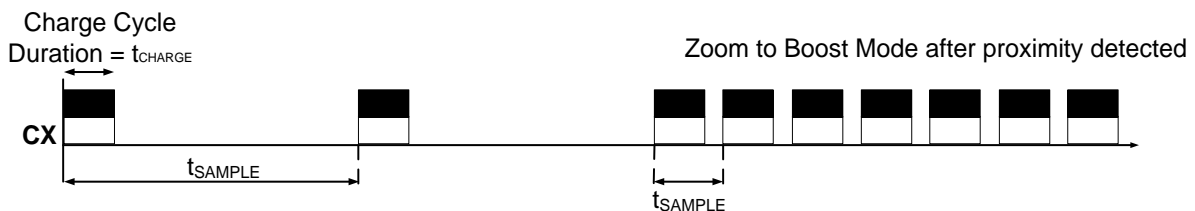

Figure 5.4: LP Modes: Charge cycles



5.7 Base Values

The sensitivity of the IQS227AS/B can be changed by adjusting the base value of the ATI algorithm, and as a result changing the compensation required to reach the target.

$$\text{Sensitivity} = \frac{\text{TARGET}}{\text{BASE}}$$

The target of the IQS227AS/B is fixed at 1000 counts.

Configuration: [Bank1 bit2-0](#)

BASE: Base Value Select -

Bit	Selection
000	200
001	50
010	75
011	100
100	150
101	250
110	300
111	500

5.8 Multipliers

When using partial ATI, the base value is set up using the multipliers. Compensation will still be added automatically to reach the target.

5.9 Charge Transfer

The charge transfer frequency of the IQS227AS/B is adjustable. Changing the transfer frequency will affect sensitivity and response rate. Two options are available:

Configuration: [Bank2 bit6](#)

TRANS: Charge Transfer Frequency

Bit	Selection
0	512kHz
1	250kHz

5.10 ATI Target Counts

The target of the ATI algorithm can be adjusted between 1024 (default) and 512 counts. When less sensitivity is required, the lower counts will also increase response rate.

Configuration: [Bank2 bit3](#)

Target: ATI Target Counts

Bit	Selection
0	1024
1	512

5.11 Noise Detect

ND: RF Noise Detection

The IQS227AS/B has RF Noise Detect (ND) functionality. If ND function is enabled, the IQS227AS/B is able to detect RF Noise on the TOUT pin. Further details on the working of this can be found in the Application Notes: AZD015 and AZD015b.

In extremely noise environments, and close proximity to RF noise sources, the noise detect of the IQS227AS/B can be enable to block false triggers. Proper layout guidelines should always be used before the need to use ND.

Configuration: [Bank2 bit4](#)

ND: Noise Detect

Bit	Selection
0	Disabled
1	Enabled

5.12 Enable Partial ATI

In some applications the startup time of the IQS227AS/B may be required to be decreased. This is possible by enabling partial ATI, if the multipliers required can be determined, and the compensation alone is adequate to account for environmental change.

Configuration: [Bank2 bit2](#)

ATI: Partial ATI

Bit	Selection
0	Disabled
1	Enabled

5.13 Filters used by the IQS227AS/B

The IQS227AS/B devices employ various signal processing functions that includes the execution of various filters as described below.

5.13.1 Long Term Average (LTA)

Capacitive touch devices detect changes in capacitance that are not always related to the



intended proximity or touch of a human. This is a result of changes in the environment of the sense plate and other factors. These changes need to be compensated for in various manners in order to reliably detect touch events and especially to detect proximity events. One mechanism the IQS227AS/B employs is the use of a Long Term Averaging filter (IIR type filter) which tracks slow changes in the environment (expressed as changes in the counts). The result of this filter is a Long Term Average (LTA) value that forms a dynamic reference used for various functions such as identification of proximity and touch events.

The LTA is calculated from the counts (CS). The filter only executes while no proximity or touch event is detected to ensure compensation only for environmental changes. However there may be instances where sudden changes in the environment or changes in the environment while a proximity or touch event has been detected cause the counts to drift away from the LTA. To compensate for these situations a Halt Timer (t_{HALT}) has been defined.

The Halt Timer is started when a proximity or touch event occurs and when it expires the LTA filter is recalibrated. Recalibration causes $LTA < CS$, thus the disappearance of proximity or touch events (refer to 5.4 and 5.5).

The designer needs to select a Halt Timer value to best accommodate the required application.

Configuration: Bank1 bit7-6

$t_{HALT1}:t_{HALT0}$: Halt time of Long Term Average	
Bit	Selection
00	20 seconds
01	40 seconds
10	NEVER
11	ALWAYS (Proximity on 40 seconds)

Notes:

- > The “NEVER” option indicates that the execution of the filters will never be halted.
- > With the ‘ALWAYS’ option and the detection of a proximity event the execution of the filter will be halted for only 40 seconds and with the detection of a touch event the execution of the filter will be halted as long as the touch condition applies.

Refer to Application note “AZD024 - Graphical Representation of the IIR Filter” for detail regarding the execution of the LTA filter.

5.13.2 IIR Raw Data filter

The extreme sensitivity of the IQS227AS/B makes it susceptible to external noise sources. This causes a decreased signal to noise (S/N) ratio, which could potentially cause false event detections.

Noise can also couple into the device as a result of poor PCB, sense electrode design and other factors influencing capacitive sensing devices.

In order to compensate for noise the IQS227AS/B uses an IIR filter on the raw data to minimize result of noise in the counts. This filter is implemented on all of the IQS227AS/B devices, and cannot be disabled.

6 Data Streaming Mode

The IQS227AS/B has the capability to stream data to a MCU. This provides the designer with the capability to obtain the parameters within the device in order to aid design into applications. Data streaming may further be used by an MCU to control events or further process results obtained from the IQS227AS/B devices. Data streaming is performed as a 1-wire data protocol on TOUT, OR set to I²C streaming (SDA on POUT, SCL on TOUT). Data Streaming can be enabled as indicated below:

Configuration: Bank2 bit7

COMMS: Data Streaming	
Bit	Selection
0	Disabled
1	Enabled

Configuration: Bank2 bit5

STREAMING: Data streaming mode	
Bit	Selection
0	1-Wire
1	I ² C

Data streaming is initiated by the IQS227AS/B. When data streaming is enabled data is sent following each charge.

Figure 6.1 illustrates the communication protocol for initialising and sending data with the 1 wire communication protocol.



1. Communication is initiated by a START bit. Bit defined as a low condition for t_{START} .
2. Following the START bit, is a synchronisation byte ($T_{INIT} = 0xAA$). This byte is used by the MCU for clock synchronisation.
3. Following T_{INIT} the data bytes will be sent. With short data streaming mode

enabled, 5 bytes of data will be sent, otherwise 8 bytes will be sent after each charge cycle.

4. Each byte sent will be preceded by a START bit and a STOP bit will follow every byte.
5. STOP bit indicated by taking pin 1 high. The STOP bit does not have a defined period.

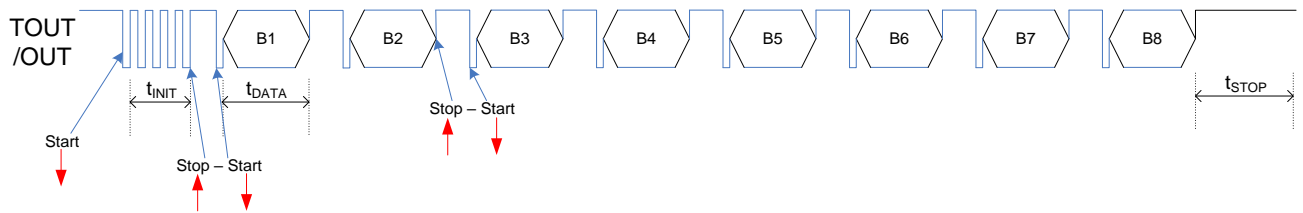

Figure 6.1: 1-wire data streaming mode

The following table defines the data streamed from the IQS227AS/B devices during the 1-wire streaming protocol.



Table 6.1: Byte Definitions for 1-Wire Data Streaming Mode

Byte (B)	Bit	Value
0		AA
1	7:0	CS High byte
2	15:8	CS Low byte
3	23:16	LTA High byte
4	31:24	LTA Low byte
5 Sys Flags	39	~
	38	~
	37	Active High
	36	Filter Halt
	35	LP active
	34	ATI Busy
	33	Noise Found
	32	In Zoom
6	47	Touch
	46	Proximity
	45	Multipliers
	44	Multipliers
	43	Multipliers
	42	Multipliers
	41	Multipliers
40	Multipliers	
7	55:48	Compensation
8	63:56	Counter

6.1 Event Mode

The IQS227AS/B has Event Mode implemented during 1-wire communication. This allows the MCU to monitor the POUT pin for status changes (proximity or touch made or released events) instead of capturing data continuously. Upon a status change, the IQS227AS/B will pull the POUT pin for low to indicate to the MCU to read data. The POUT pin will stay low for 1.6ms.

6.2 I²C

The IQS227AS/B also allows for I²C streaming for debugging. Data Streaming can be changed from 1-wire protocol to I²C as shown below:

Configuration: Bank2 bit7: Streaming Mode

Bit	Selection
0	1-Wire Protocol
1	I ² C Streaming

The Memory Map for the IQS227AS/B can be found in Appendix A.

The IQS227AS/B can communicate on an I²C compatible bus structure. Note that 4.7kΩ pull-up resistors should be placed on SDA and SCL.

The Control byte indicates the 7-bit device address (0x44H) and the Read/Write indicator bit.

7 Auto Tuning Implementation (ATI)

ATI is a sophisticated technology implemented in the latest generation ProxSense® devices that optimises the performance of the sensor in a wide range of applications and environmental conditions (refer to application note AZD0027 - Auto Tuning Implementation).

ATI makes adjustments through external reference capacitors (as required by most other solutions) to obtain optimum performance.

ATI adjusts internal circuitry according to two parameters, the ATI multiplier and the ATI compensation. The ATI multiplier can be viewed as a course adjustment and the ATI compensation as a fine adjustment.

The adjustment of the ATI parameters will result in variations in the counts and sensitivity. Sensitivity can be observed as the change in current sample as the result of a fixed change in sensed capacitance. The ATI parameters have been chosen to provide significant overlap. It may therefore be possible to select various combinations of ATI multiplier and ATI compensation settings to obtain the same count value. The sensitivity of the various options may however be different for the same count value.

7.1 Automatic ATI

The IQS227AS/B implements an automatic ATI algorithm. This algorithm automatically adjusts the ATI parameters to optimise the sensing electrodes connection to the device.



The device will execute the ATI algorithm whenever the device starts-up and when the counts are not within a predetermined range.

While the Automatic ATI algorithm is in progress this condition will be indicated in the streaming data and proximity and touch events cannot be detected. The device will only briefly remain in this condition and it will be entered only when relatively large shifts in the counts has been detected.

The automatic ATI function aims to maintain a constant count value, regardless of the capacitance of the sense electrode (within the maximum range of the device).

The effects of auto-ATI on the application are the following:

- > Automatic adjustment of the device configuration and processing parameters for a wide range of PCB and application designs to maintain an optimal configuration for proximity and touch detection.
- > Automatic tuning of the sense electrode at start-up to optimise the sensitivity of the application.
- > Automatic re-tuning when the device detects changes in the sensing electrodes capacitance to accommodate a large range of changes in the environment of the application that influences the sensing electrode.
- > Re-tuning only occurs during device operation when a relatively large sensitivity reduction is detected. This is to ensure smooth operation of the device during operation.
- > Re-tuning may temporarily influence the normal functioning of the device, but in most instances the effect will be hardly noticeable.
- > Shortly after the completion of the re-tuning process the sensitivity of a Proximity detection may be reduced slightly for a few seconds as internal filters stabilises.

Automatic ATI can be implemented so effectively due to:

- > Excellent system signal to noise ratio (SNR).
- > Effective digital signal processing to remove AC and other noise.

- > The very stable core of the devices.
- > Built in capability to accommodate a large range of sensing electrode capacitances.

7.2 IQS227AS/B Noise Immunity

The IQS227AS/B has advanced immunity to RF noise sources such as GSM cellular telephones, DECT, Bluetooth and WIFI devices. Design guidelines should however be followed to ensure the best noise immunity. The design of capacitive sensing applications can encompass a large range of situations but as a summary the following should be noted to improve a design:

- > A ground plane should be placed under the IC, except under the Cx line.
- > All the tracks on the PCB must be kept as short as possible.
- > The capacitor between V_{DDHI} and GND as well as between V_{REG} and GND, must be placed as close as possible to the IC.
- > A 100pF capacitor can be placed in parallel with the 1uF capacitor between V_{DDHI} and GND. Another 100pF capacitor can be placed in parallel with the 1uF capacitor between V_{REG} and GND.
- > When the device is too sensitive for a specific application a parasitic capacitor (typically up to 20pF) can be added between the Cx line and ground.
- > Proper sense electrode and button design principles must be followed.
- > Unintentional coupling of sense electrode to ground and other circuitry must be limited by increasing the distance to these sources or making use of the driven shield.
- > In some instances, a ground plane some distance from the device and sense electrode may provide significant shielding from undesired interference.
- > When then the capacitance between the sense electrode and ground becomes too large the sensitivity of the device may be influenced.

Note: ND input enable is a legacy input and is not recommended for use in new designs. The input has been desensitized by default and is not tested to trigger at a specific RF input power level



8 Electrical Specifications

8.1 Absolute Maximum Specifications

Exceeding these maximum specifications may cause damage to the device.

Operating temperature	IQS227AS	-20°C to 85°C
	IQS227B	-40°C to 85°C
Supply Voltage ($V_{DDHI} - V_{SS}$)		3.6V
Maximum pin voltage (T_{OUT}, P_{OUT})		$V_{DDHI} + 0.3V$
Pin voltage (C_x)		1.7V
Minimum pin voltage ($V_{DDHI}, V_{REG}, T_{OUT}, P_{OUT}, C_x$)		$V_{SS} - 0.3V$
Minimum power-on slope		100V/s
HBM ESD protection ($V_{DDHI}, V_{REG}, V_{SS}, T_{OUT}, P_{OUT}, C_x$)		8kV

8.2 General Characteristics

The IQS227AS/B devices are rated for supply voltages between 1.8V and 3.6V.

Table 8.1: IQS227AS/B General Operating Conditions (Self)

DESCRIPTION	Conditions	PARAMETER	MIN	TYP	MAX	UNIT
Supply voltage		V_{DDHI}	1.8	3.3	3.6	V
Internal regulator output	$1.8 \leq V_{DDHI} \leq 3.6$	V_{REG}	1.64	1.7	1.75	V
Boost operating current	$1.8 \leq V_{DDHI} \leq 3.6$	$I_{IQS227AS/B_BP}$	119	128	135	μA
Normal operating current	$1.8 \leq V_{DDHI} \leq 3.6$	$I_{IQS227AS/B_NP}$	4.7	6	7.6	μA
Low power operating current	$1.8 \leq V_{DDHI} \leq 3.6$	$I_{IQS227AS/B_LP1}$	2.8	3.5	4.7	μA
Low power operating current	$1.8 \leq V_{DDHI} \leq 3.6$	$I_{IQS227AS/B_LP2}$	1.75	<2.5 ¹	3	μA
C_x pin capacitance	$1.8 \leq V_{DDHI} \leq 3.6$	C_{CxLoad}			120	pF

Charge Transfer Timings for low power modes are found in Section 5.6.

Table 8.2: Start-up and shut-down slope Characteristics

DESCRIPTION	Conditions	PARAMETER	MIN	MAX	UNIT
POR	V_{DDHI} Slope $\geq 100V/s$	POR	0.3 ²	1.7	V
VDDHI reset level	V_{DDHI} Slope $\geq 100V/s$	$RESET_{VDDHI}$	N/A	1.7	V
VREG reset level	V_{DDHI} Slope $\geq 100V/s$	$RESET_{VREG}$	N/A	1.58 ³	V

¹ All low power current values arise from characterization done from (-)35°C to (+)85°C at 3.3V

² For a power cycle, ensure lowering VDDHI below the minimum value before ramping VDDHI past the maximum POR value

³ Figure 2.4 Capacitors C1 & C3 should be chosen to comply with this specification



8.3 Output Characteristics

Table 8.3: TOUT Characteristics

Symbol	Description	V _{OH}	Conditions	MIN	TYP	MAX	UNIT
I _{SOURCE}	Output High voltage	0.9*VDDHI	V _{DDHI} = 3.6V	~	~	TBD	mA
		0.9*VDDHI	V _{DDHI} = 3.3V	~	10	~	
		0.9*VDDHI	V _{DDHI} = 1.8V	TBD	~	~	
Symbol	Description	V _{OL}	Conditions	MIN	TYP	MAX	UNIT
I _{SINK}	Output Low voltage	0.1V	V _{DDHI} = 3.6V			TBD	mA
		0.1V	V _{DDHI} = 3.3V		10		
		0.1V	V _{DDHI} = 1.8V	TBD			

Table 8.4: POUT Characteristics

Symbol	Description	VOH	Conditions	MIN	TYP	MAX	UNIT
I _{SOURCE}	Output High voltage	0.9*VDDHI	V _{DDHI} = 3.6V	~	~	TBD	mA
		0.9*VDDHI	V _{DDHI} = 3.3V	~	10	~	
		0.9*VDDHI	V _{DDHI} = 1.8V	TBD	~	~	
Symbol	Description	V _{OL}	Conditions	MIN	TYP	MAX	UNIT
I _{SINK}	Output Low voltage	0.1V	V _{DDHI} = 3.6V			TBD	mA
		0.1V	V _{DDHI} = 3.3V		10		
		0.1V	V _{DDHI} = 1.8V	TBD			

Table 8.5: Combined Characteristics

Symbol	Description	VOH	Conditions	MIN	TYP	MAX	UNIT
I _{SOURCE}	Output High voltage	0.9*VDDHI	V _{DDHI} = 3.6V	~	~	TBD	mA
		0.9*VDDHI	V _{DDHI} = 3.3V	~	17	~	
		0.9*VDDHI	V _{DDHI} = 1.8V	TBD	~	~	
Symbol	Description	V _{OL}	Conditions	MIN	TYP	MAX	UNIT
I _{SINK}	Output Low voltage	0.1V	V _{DDHI} = 3.6V			TBD	mA
		0.1V	V _{DDHI} = 3.3V		20		
		0.1V	V _{DDHI} = 1.8V	TBD			



8.4 Packaging Information

8.4.1 TSOT23-6

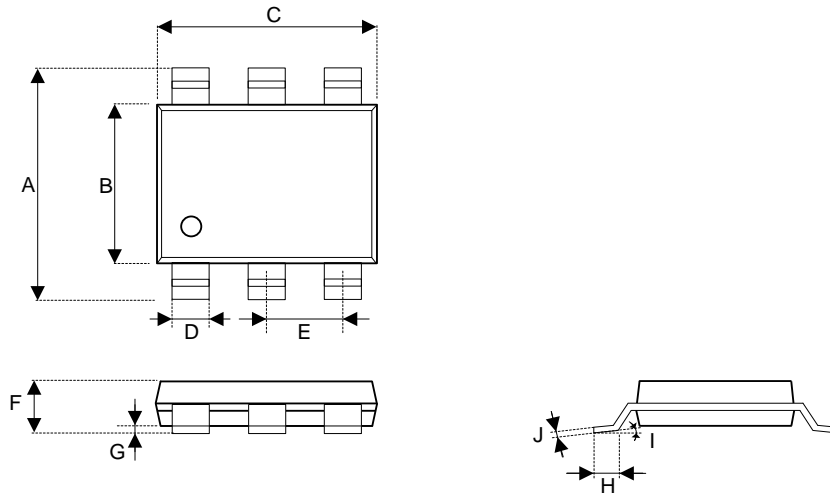

Figure 8.1 TSOT23-6 Packaging⁴

Table 8.6 TSOT23-6 Dimensions

Dimension	Min	Max
A	2.60mm	3.00mm
B	1.50mm	1.70mm
C	2.80mm	3.00mm
D	0.30mm	0.50mm
E	0.95 Basic	
F	0.84mm	1.00mm
G	0.00mm	0.10mm
H	0.30mm	0.50mm
I	0°	8°
J	0.03mm	0.20mm

⁴ Drawing not on Scale



8.4.2 WLCSP-8

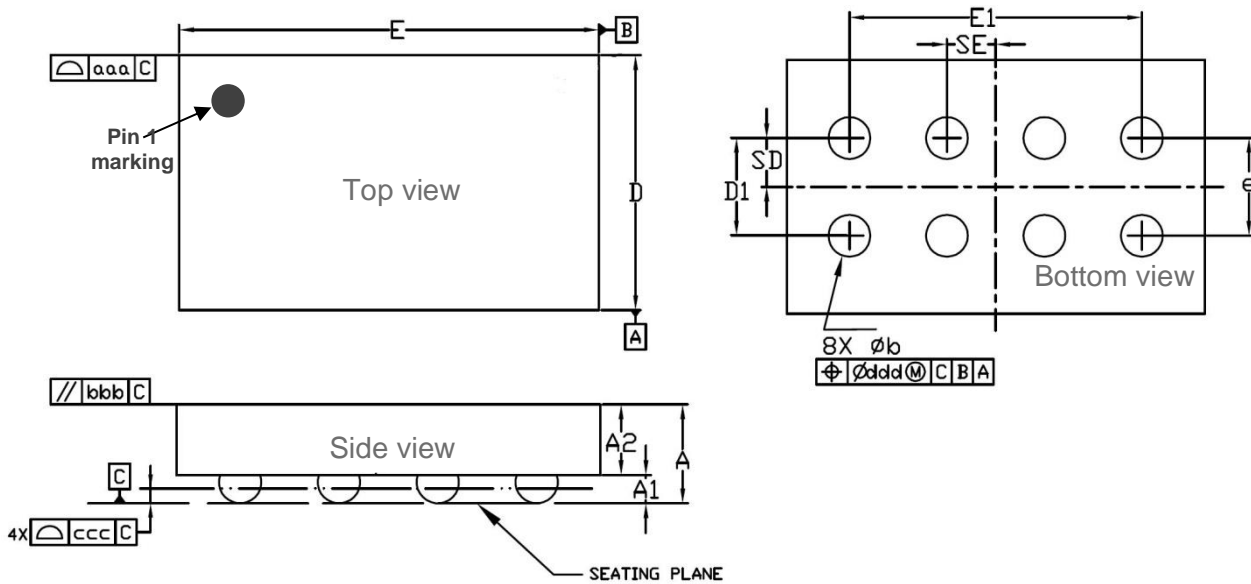

Dimensional Ref.			
REF.	Min.	Nom.	Max.
A	0.310	0.350	0.390
A1	0.085	0.100	0.115
A2	0.225	0.250	0.275
D	0.865	0.880	0.895
E	1.455	1.470	1.485
D1	0.300	0.350	0.400
E1	1.000	1.050	1.100
b	0.125	0.150	0.175
e	0.350 BSC		
SD	0.175 BSC		
SE	0.175 BSC		
Tol. of Form&Position			
aaa	0.10		
bbb	0.10		
ccc	0.05		
ddd	0.05		

Figure 8.2 IQS227B WLCSP-8 Dimensions (in mm)



8.4.3 DFN-6

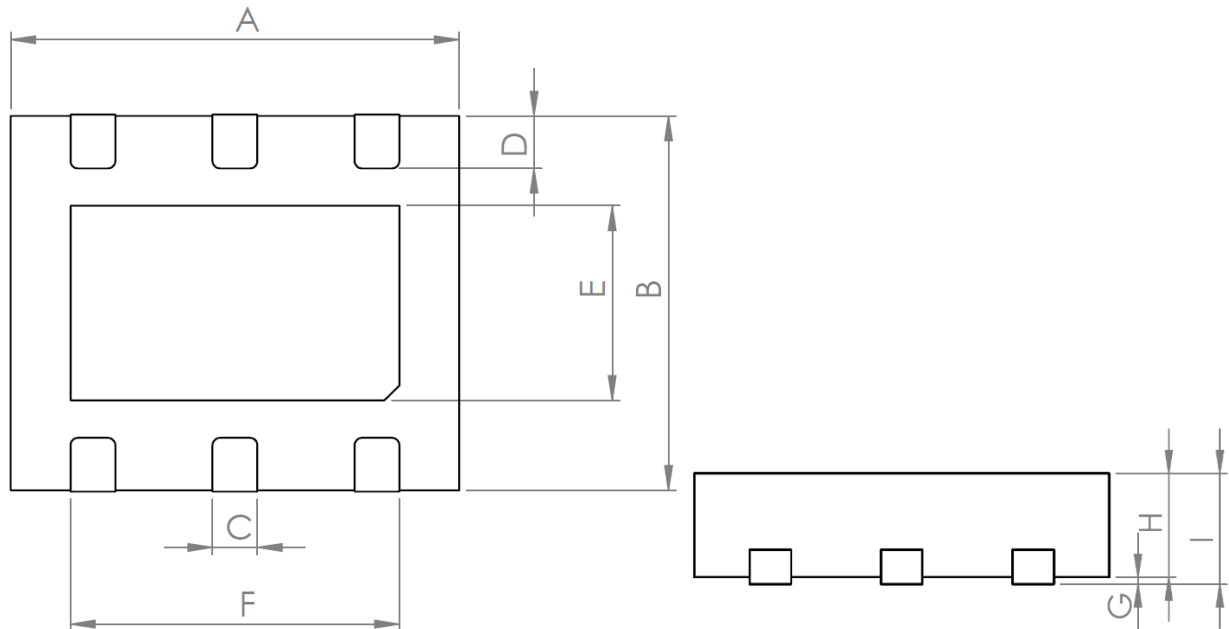

DFN-6 Packaging

DFN-6 Dimensions

Dimension	Min	Max
A	3.00mm	3.00mm
B	2.50mm	2.50mm
C	0.30mm	0.30mm
D	0.35mm	0.35mm
E	1.30mm	1.30mm
F	2.20mm	2.20mm
G	0.05mm	0.05mm
H	0.75mm	0.75mm
I	0.80mm	0.80mm



8.5 Package MSL

Moisture Sensitivity Level (MSL) relates to the packaging and handling precautions for some semiconductors. The MSL is an electronic standard for the time period in which a moisture sensitive device can be exposed to ambient room conditions (approximately 30°C/85%RH see J-STD033C for more info) before reflow occur.

Table 8.7:MSL

Package	Level (duration)
TSOT23-6	MSL 1 (Unlimited at ≤30 °C/85% RH) Reflow profile peak temperature < 260 °C for < 30 seconds
WLCSP-8	Non-encapsulated device – not moisture sensitive Reflow profile peak temperature < 260 °C for < 30 seconds
DFN-6	MSL 1 (Unlimited at ≤30 °C/85% RH) Reflow profile peak temperature < 260 °C for < 30 seconds



9 Datasheet and Part-number Information

9.1 Ordering Information

Orders will be subject to a MOQ (Minimum Order Quantity) of a full reel. Contact the official distributor for sample quantities. A list of the distributors can be found under the “Distributors” section of www.azoteq.com.

For large orders, Azoteq can provide pre-configured devices.

The Part-number can be generated by using USBProg.exe or the Interactive Part Number generator on the website.

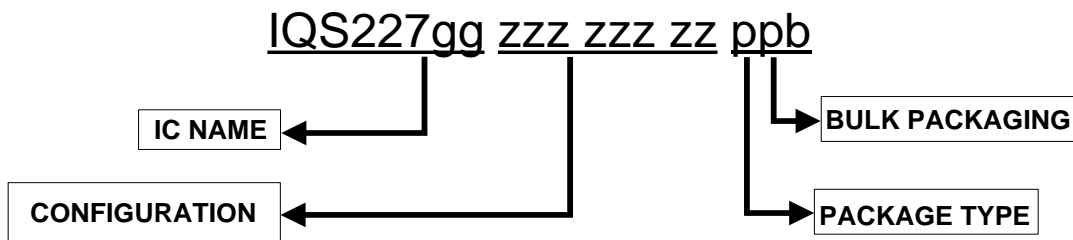

IC NAME	IQS227AS	=	IQS228 Self Capacitive
	IQS227B	=	IQS228 Self Capacitive
CONFIGURATION	zzz zzz zz	=	IC Configuration (hexadecimal)
PACKAGE TYPE	TS	=	TSOT23-6 package
	CS	=	WLCSP-8 package
	DN	=	DFN-6 package
BULK PACKAGING	R	=	Reel
			TSOT23-6 and WLCSP-8: 3000pcs/reel
			DFN-6: 6000pcs/reel
		=	MOQ = 1 reel (orders shipped as full reels)



9.2 Device Marking – Top

9.2.1 TSOT23-6 Packaging Markings

There are 2 marking versions in circulation for IQS227AS and IQS227B:

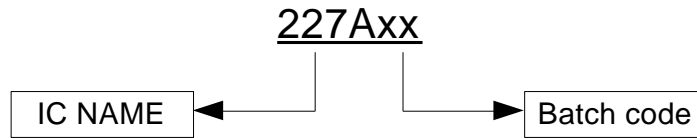

Figure 9.1: First Marking Variant of IQS227AS

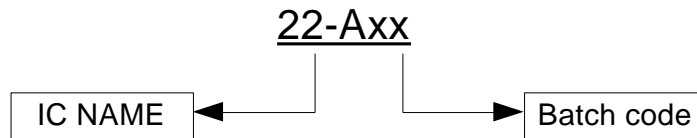

Figure 9.2: Second Marking Variant of IQS227AS

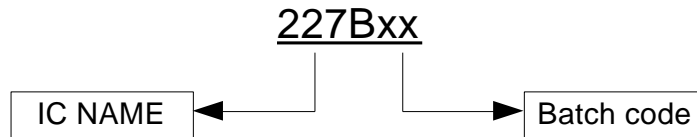

Figure 9.3: First Marking Variant of IQS227B

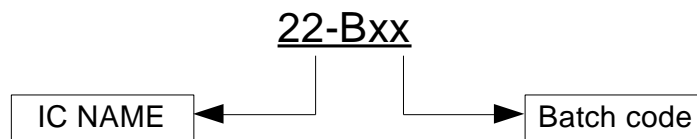

Figure 9.4: Figure 10 4 Second Marking Variant of IQS227B

IC NAME	227A	=	IQS227AS Self Capacitive
	22-A	=	IQS227AS Self Capacitive
	227B	=	IQS227B Self Capacitive
	22-B	=	IQS227B Self Capacitive
Batch Code	xx	=	AA to ZZ



9.4 Tape & Reel Specification

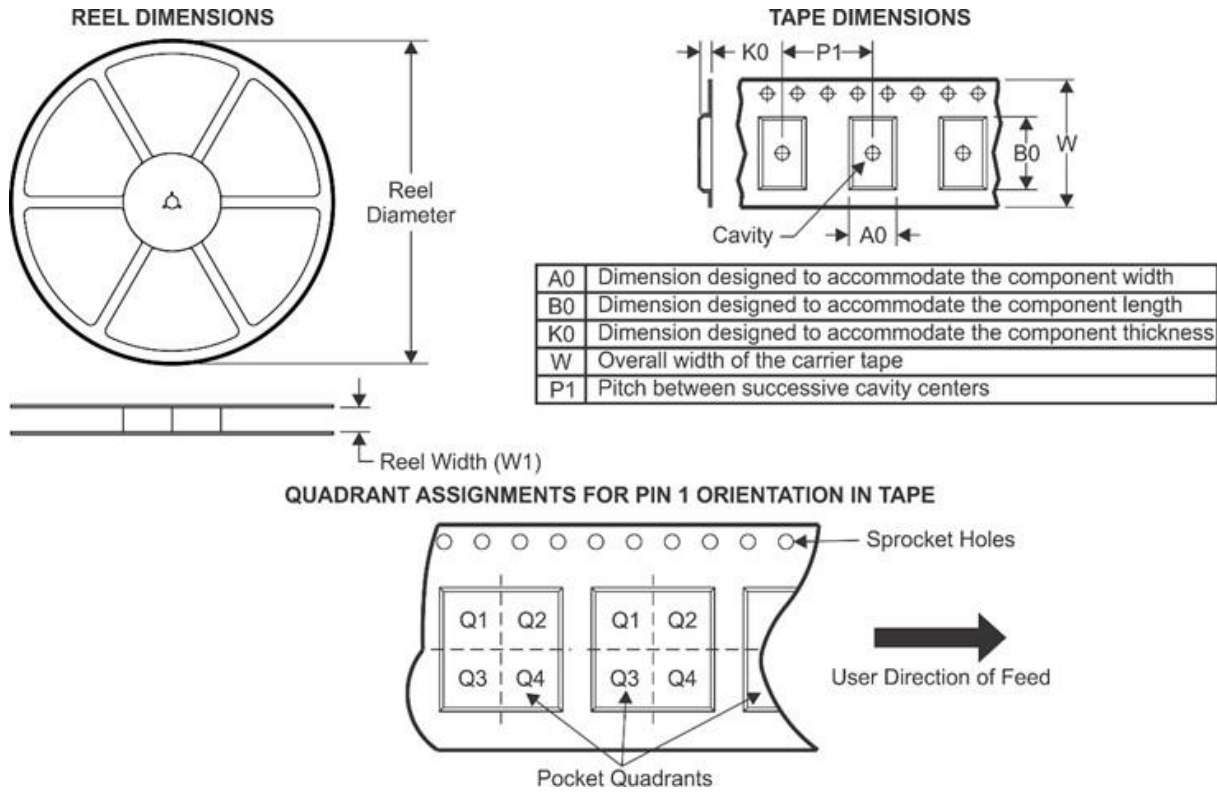

Figure 9.7: Tape and Reel Specification.

Table 9.1 Tape and Reel Dimensions

Device	Package Type	Package Drawing	Pins	QTY per reel	Reel Diameter (mm)	Reel Width W1 (mm)	A0 (mm)	B0 (mm)	K0 (mm)	P1 (mm)	W (mm)	Pin1 Quadrant
IQS227ASzzzzzzzTSR	TSOT23/6	TSOT23-6	6	3000	178	9.5	3.1	3.1	1.3	4	8	Q3
IQS227BzzzzzzzTSR	TSOT23/6	TSOT23-6	6	3000	178	9.5	3.1	3.1	1.3	4	8	Q3
IQS227BzzzzzzzCSR	WLCSP8	WLCSP-8	8	3000	179	8.4	1	1.55	0.48	4	8	Q3
IQS227BzzzzzzzDNR	DFN6	DFN-6	6	6000	330	12.4	2.8	3.3	1.2	4	12	Q1



Appendix A. Memory Map

Device Information

		Product Number (PROD_NR)							
		Bit	7	6	5	4	3	2	1
Access		Value							
	R	39 (Decimal)							
		Note							

		Software Number (SW_NR)							
		Bit	7	6	5	4	3	2	1
Access		Value							
	R	28 (Decimal)							
		Note							

[00H] PROD_NR

The product number for the IQS227AS/B is 39 (decimal).

[01H] SW_NR

The software version number of the device ROM can be read in this byte. The latest software version is 28 (decimal).

		System Flags (Sys_Flags)							
		Bit	7	6	5	4	3	2	1
Access		Value							
	R	~	~	Logic	Halt	LP	ATI	ND	Zoom
		Note							

[10H] SYSFLAGS0

Bit 7: **SYSTEM_USE**

Bit 6: **SYSTEM_USE**

Bit 5: **Logic:** Logic Output Indication

0 = Active Low

1 = Active High

Bit 4: **Halt:** Indicates Filter Halt status

0 = LTA not being Halted

1 = LTA Halted

Bit 3: **LP:** Low Power Mode

0 = Sample time BP

1 = Sample time LP



- Bit 2:** **ATI:** Status of automated ATI routine
0 = ATI is not busy
1 = ATI in progress
- Bit 1:** **ND:** This bit indicates the presence of noise interference.
0 = IC has not detected the presence of noise
1 = IC has detected the presence of noise
- Bit 0:** **ZOOM:** Zoom will indicate full-speed charging once an undebounced proximity is detected. In BP mode, this will not change the charging frequency.
0 = IC not zoomed in
1 = IC detected undebounced proximity and IC is charging at full-speed (BP)

		Status								
		Bit	7	6	5	4	3	2	1	0
Access									Touch	Prox
R										

[31H] Status

- Bit 1:** **Touch:** Touch indication bit.
0 = No Touch Detected
1 = Touch Event Detected
- Bit 0:** **Prox:** Proximity indication bit.
0 = No Proximity Detected
1 = Proximity Event Detected

		Counts_Hi (CS_H)							
		Bit	7	6	5	4	3	2	1
Access		Counts High Byte							
R									

		Counts_Low (CS_L)							
		Bit	7	6	5	4	3	2	1



Access	Value	Counts Low Byte							
R	Note								

83H	LTA_Hi (LTA_H)								
	Bit	7	6	5	4	3	2	1	0
Access	Value	Long Term Average High Byte							
R	Note								

84H	LTA_Low (LTA_L)								
	Bit	7	6	5	4	3	2	1	0
Access	Value	Long Term Average Low Byte							
R	Note								

C4H	Fuse Bank 0 (FB_0)								
	Bit	7	6	5	4	3	2	1	0
Access	Value	See 0 for more details							
R	Note								

C5H	Fuse Bank 1 (FB_1)								
	Bit	7	6	5	4	3	2	1	0
Access	Value	See Table 3.2 for more details							
R	Note								

C6H	Fuse Bank 2 (FB_2)								
	Bit	7	6	5	4	3	2	1	0
Access	Value	See Table 3.4 for more details							



R	Note	
---	------	--

C7H	Fuse Bank 3 (FB_3)								
Access	Bit	7	6	5	4	3	2	1	0
R	Value	Not used							
R	Note								

C8H	DEFAULT_COMMS_POINTER								
Access	Bit	7	6	5	4	3	2	1	0
R/W	Value	(Beginning of Device Specific Data)							
R/W	Default	10H							

[C8H] Default Comms Pointer

The value stored in this register will be loaded into the Comms Pointer at the start of a communication window. For example, if the design only requires the Proximity Status information each cycle, then the *Default Comms Pointer* can be set to ADDRESS '31H'. This would mean that at the start of each communication window, the comms pointer would already be set to the Proximity Status register, simply allowing a READ to retrieve the data, without the need of setting up the address.



Appendix B. Contact Information

	USA	Asia	South Africa
Physical Address	11940 Jollyville Suite 120-S Austin TX 78750 USA	Room 501A, Block A, T-Share International Centre, Taoyuan Road, Nanshan District, Shenzhen, Guangdong, PRC	1 Bergsig Avenue Paarl 7646 South Africa
Postal Address	11940 Jollyville Suite 120-S Austin TX 78750 USA	Room 501A, Block A, T-Share International Centre, Taoyuan Road, Nanshan District, Shenzhen, Guangdong, PRC	PO Box 3534 Paarl 7620 South Africa
Tel	+1 512 538 1995	+86 755 8303 5294 ext 808	+27 21 863 0033
Email	info@azoteq.com	info@azoteq.com	info@azoteq.com

Visit www.azoteq.com
for a list of distributors and worldwide representation.

Patents as listed on www.azoteq.com/patents-trademarks/ may relate to the device or usage of the device.

Azoteq®, Crystal Driver®, IQ Switch®, ProxSense®, ProxFusion®, LightSense™, SwipeSwitch™, and the  logo are trademarks of Azoteq.

The information in this Datasheet is believed to be accurate at the time of publication. Azoteq uses reasonable effort to maintain the information up-to-date and accurate, but does not warrant the accuracy, completeness or reliability of the information contained herein. All content and information are provided on an "as is" basis only, without any representations or warranties, express or implied, of any kind, including representations about the suitability of these products or information for any purpose. Azoteq disclaims all warranties and conditions with regard to these products and information, including but not limited to all implied warranties and conditions of merchantability, fitness for a particular purpose, title and non-infringement of any third party intellectual property rights. Azoteq assumes no liability for any damages or injury arising from any use of the information or the product or caused by, without limitation, failure of performance, error, omission, interruption, defect, delay in operation or transmission, even if Azoteq has been advised of the possibility of such damages. The applications mentioned herein are used solely for the purpose of illustration and Azoteq makes no warranty or representation that such applications will be suitable without further modification, nor recommends the use of its products for application that may present a risk to human life due to malfunction or otherwise. Azoteq products are not authorized for use as critical components in life support devices or systems. No licenses to patents are granted, implicitly, express or implied, by estoppel or otherwise, under any intellectual property rights. In the event that any of the abovementioned limitations or exclusions does not apply, it is agreed that Azoteq's total liability for all losses, damages and causes of action (in contract, tort (including without limitation, negligence) or otherwise) will not exceed the amount already paid by the customer for the products. Azoteq reserves the right to alter its products, to make corrections, deletions, modifications, enhancements, improvements and other changes to the content and information, its products, programs and services at any time or to move or discontinue any contents, products, programs or services without prior notification. For the most up-to-date information and binding Terms and Conditions please refer to www.azoteq.com.