



Application Note: AZD052b

Conducted Immunity: Quick Guide

(Please refer to AZD052 for the full application note)

1 Introduction:

- Long cables are at risk of picking up RF, but to test this below 80MHz – require very large antennas (few metres long) – not practical
- So simulate with injected noise currents, as if radiated RF has successfully coupled into cables, with relevant generic international standard: **IEC61000-4-6**
- IEC61000-4-6: Common mode noise – noise currents flow in same direction toward earth and noise is of continuous nature, with amplitude modulation – not pulsing/surges
- Capacitive sensing – may be very sensitive to common mode noise, but with proper PCB layout and correct use of common mode impedance immunity may be improved significantly.
- ProxSense design common mode impedance very NB for noise immunity.
- Real world – common mode and differential mode conducted noise. Latter typically from SMPS. Future versions of IEC61000-4-6 may include differential mode noise as well

2 Overview of IEC 61000-4-6:

- Advisable to purchase a copy of the standard – below just an overview.
- Testing for immunity to conducted interference due to intentional **150kHz - 80MHz** transmitters.
- Three noise injection options: 1) Using Couple-Decouple Networks (**CDN's**); 2) Using Electromagnetic Clamp; 3) Using Bulk Current Injection, with current clamps.
- Seems as if **CDN** technique gives most repeatable and accurate results.
- Standard requires noise to be **amplitude modulated at 80%** depth, according to a **1kHz sine**, with levels specified as equivalent open circuit voltages of $1V_{RMS}$, $3V_{RMS}$ or $10V_{RMS}$. Commercial product level is **$3V_{rms}$ immunity**.
- Typical equipment required: Signal Generator, Amplifier, Spectrum Analyzer and CDN.
- For CDN, calibration is done for 150Ω load with applied voltage derived from open circuit voltage.
- If DC supply cable is long enough, have to inject on DC side of ProxSense design, may be harder test.
- Most ProxSense applications will be tested as table-top equipment
- Once product is powered and functional, calibration data is “played back”, frequency is swept from 150kHz to 80MHz, minimum dwell time of 0.5s and a max frequency change of 1% per step.
- Class A pass requires no false Touch / Proximity, and detecting valid Touch and Proximity events.
- IEC61000-4-6 is a fairly complex standard, easily miss-applied. For formal compliance testing, advisable to use a reputable, accredited EMC lab, and to scrutinize test method and results.

!! IEC61000-4-6 only applies to commercial products, not to Medical, Maritime, Avionics, Machinery and Automotive products where malfunction/failure could result in loss of life or large scale financial loss. Stringent international / local

standards cover such applications. Further, conducted immunity tests may involve hazardous voltages, also nominally in the DUT. Basic electrical safety principles should be applied. If unsure, consult a certified professional.

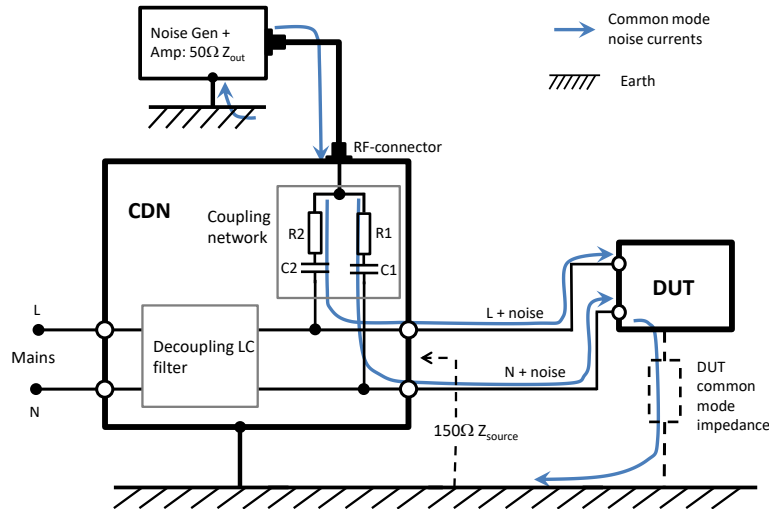
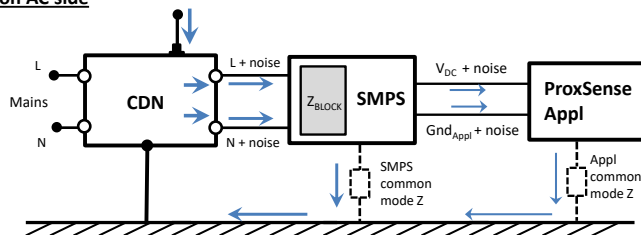

Figure 1: Injecting common mode noise into a DUT with two AC power lines, using a CDN.

Injecting on AC side



Injecting on DC side

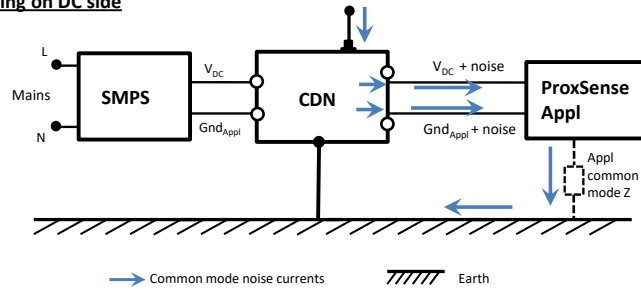

Figure 2: Injecting noise on the AC or DC side of a ProxSense application

3 Improving Conducted Noise Immunity:

- Common mode conducted noise immunity of ProxSense applications can be increased by minimizing the flow of noise currents via capacitive sensing electrodes. This may be done by: 1) Blocking the noise; 2) Shunting the noise; 3) Selectively filtering the noise 4) Burning the noise; 5) Recognizing the noise
- **Block the noise:** Typically, common mode conducted noise will reach your design via the power cables and can be blocked by common mode chokes – watch out for impedance freq dependence.

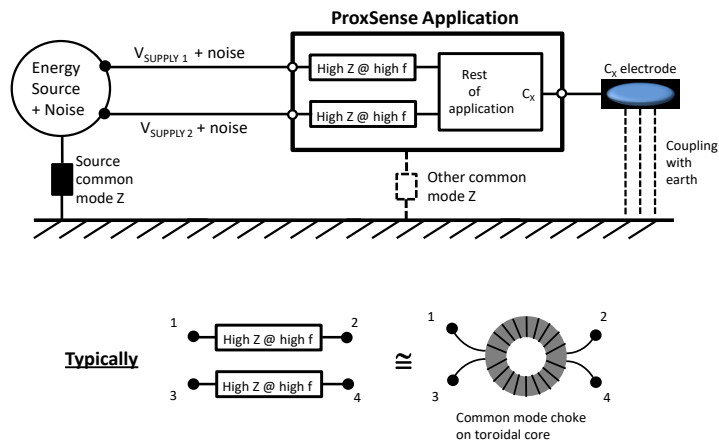

Figure 3: Blocking common mode noise currents with high impedance in each line

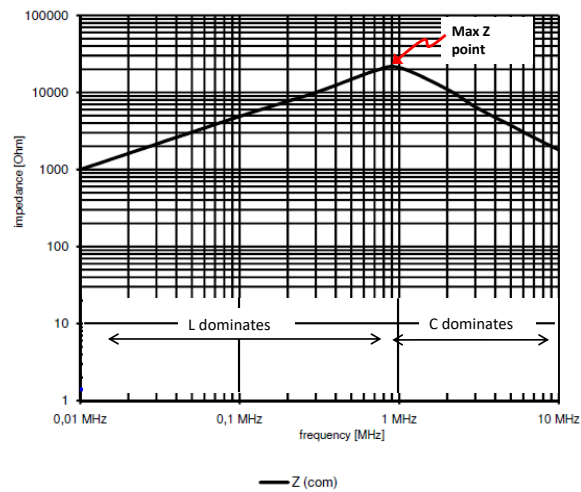

Figure 4: Common mode impedance of a typical SM common mode choke available commercially, showing dominance of inductance and parasitic winding capacitance.

- ➔ **Shunt the noise:** Noise currents may be shunted to earth by increasing voltage rail copper areas. Any rail may be used, be it Live, Neutral, V_{DC} or local ground - common mode noise. Location of additional copper is NB. If noise currents first encounter the copper of C_x electrodes, it may follow this path. Ground rings also work well. With Azoteq's high sensitivity, and PCC, ground copper may be placed directly below electrodes, significantly improving immunity.

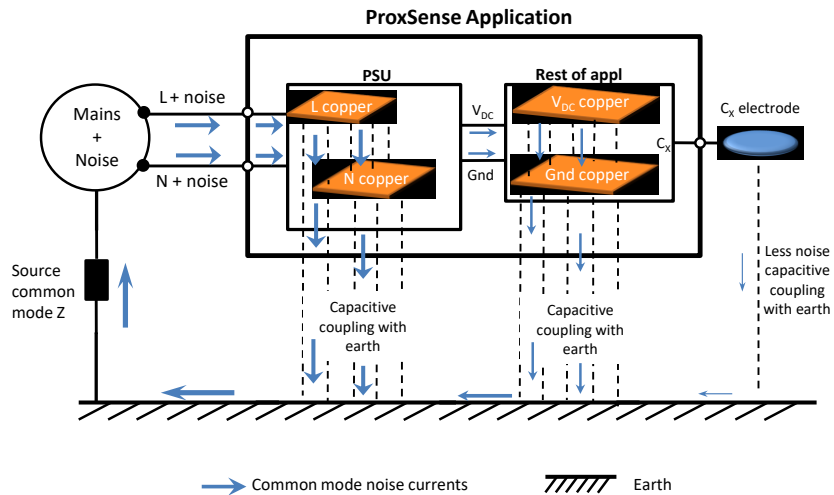

Figure 5: Shunting noise currents with additional copper to increase capacitive coupling with earth

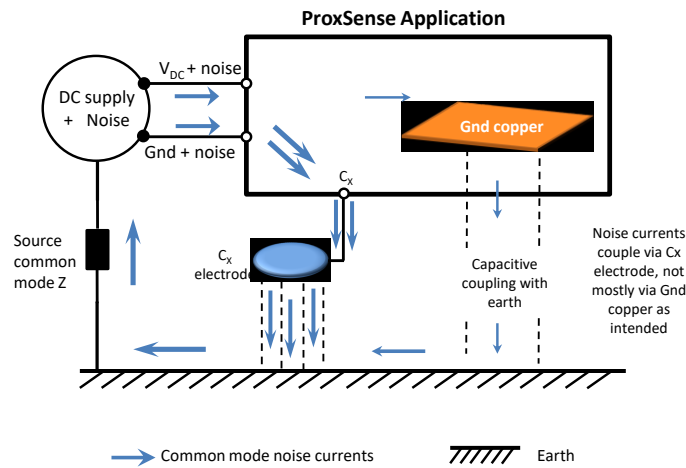

Figure 6: Physical location of additional copper is important

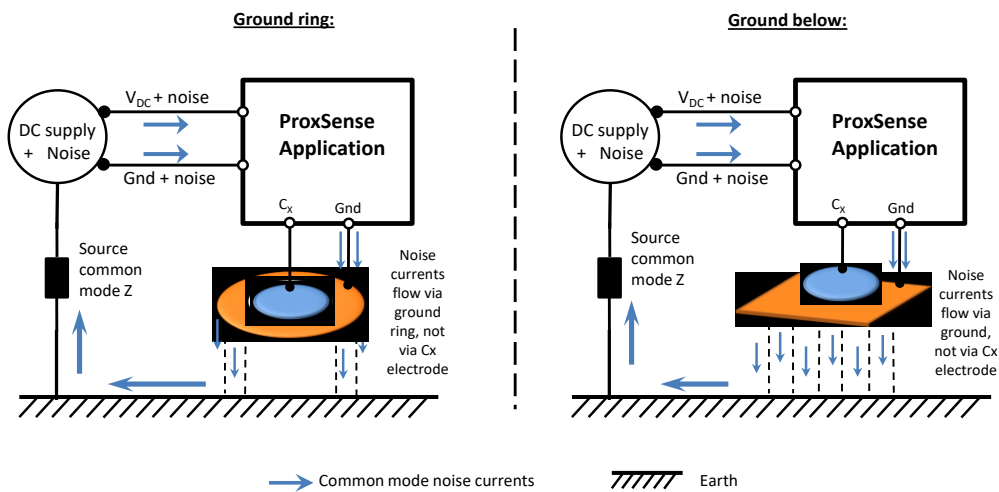

Figure 7: Use of a ground ring around and/or grounded copper below Cx electrodes to increase immunity



- **Selectively filter the noise:** Common mode noise currents may cause differential voltage drops. Due to the high conducted noise frequencies (up to 80MHz/230MHz), simple RC or LC low-pass filters may be used to prevent failures due to such differential voltages. Note that blind application of differential filters will typically not result in an immunity increase.
- **Burn the noise:** Another option is to use high resistance values (order of 1kΩ) in one or both the supply lines towards the IQSxxx device, resulting in noise energy being dissipated. This option is based on the extremely low operating currents of most IQS devices, typically well below 400μA. Note that some supply voltage drop will be generated, and must be acceptable in the application.

4 Testing alternatives:

- Below is a list of some low cost alternative test methods.
- These cannot guarantee compliance, but may give qualitative indication of immunity.
- Always try to benchmark with product that is known to comply to the relevant standard.
- Full compliance testing at accredited EMC lab still advisable.
- Signal generator with basic capacitive clamp: Cables are placed between clamp plates. Take care not to realize to large clamp capacitance – may damage signal generator output.
- Signal generator directly into local ground: Inject noise directly into the local ProxSense ground using a 50Ω -100Ω resistor to limit current. The ground reference plane is connected to the signal generator ground, and DUT is 0.1m above reference plane.
- Direct injection: Use DC-blocking capacitor in series with RF-source output to inject RF-currents directly into various conductors of the ProxSense circuit. May result in very high RF-current levels. **Please note that direct injection is a risky test**, for DUT, RF-source, and other equipment nearby. If amplifier is used a current limiting resistor is NB. **Do not pursue this alternative method if you are unsure, and follow relevant safety procedures when working with high voltages.**

!! In all the above, care must be taken not to exceed local legal limits for RF-radiation. Severe consequences, some fatal, can result if limits are exceeded. If unsure, consult an EMC specialist.

5 Differential Mode Conducted Noise:

- Real life conducted noise may be common or differential mode
- Typical sources of differential mode noise are SMPS, arcing contacts (which may also result in common mode noise – EFT), LCD screen drivers etc.
- Advise the following to improve the immunity to differential mode conducted noise:
 - Use single or two stage RC or LC filters on supply lines, especially from SMPS
 - Be wary of very low cost SMPS. Use SMPS that employ controllers with switching freq dithering.
 - Follow Radiated Immunity PCB guidelines, as described in AZD015, to minimize detrimental effects. Especially proper decoupling of Vdd and Gnd through realization of sufficient copper.
 - Take care when routing supply or capacitive sensing lines close to SMPS sections, or underneath LCD screens.

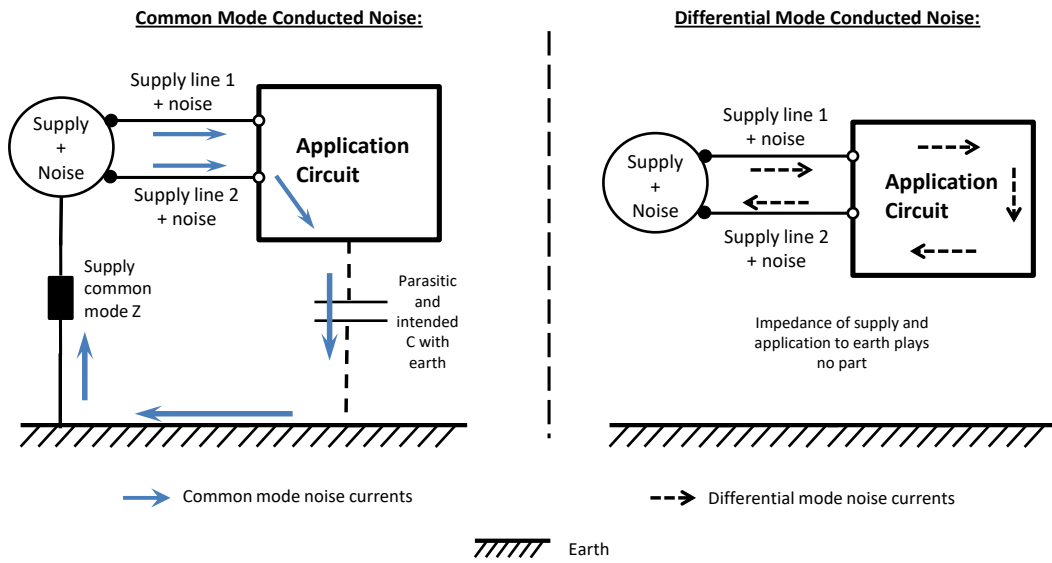

Figure 8: Common mode and differential mode conducted noise currents



Appendix A. Contact Information

	USA	Asia	South Africa
Physical Address	6507 Jester Blvd Bldg 5, suite 510G Austin TX 78750 USA	Rm1227, Glittery City Shennan Rd Futian District Shenzhen, 518033 China	109 Main Street Paarl 7646 South Africa
Postal Address	6507 Jester Blvd Bldg 5, suite 510G Austin TX 78750 USA	Rm1227, Glittery City Shennan Rd Futian District Shenzhen, 518033 China	PO Box 3534 Paarl 7620 South Africa
Tel	+1 512 538 1995	+86 755 8303 5294 ext 808	+27 21 863 0033
Fax	+1 512 672 8442		+27 21 863 1512
Email	info@azoteq.com	info@azoteq.com	info@azoteq.com

Please visit www.azoteq.com for a list of distributors and worldwide representation.

The following patents relate to the device or usage of the device: US 6,249,089; US 6,952,084; US 6,984,900; US 8,395,395; US 8,531,120; US 8,659,306; US 9,209,803; US 9,360,510; US 9,496,793; US 9,709,614; US 9,948,297; EP 2,351,220; EP 2,559,164; EP 2,748,927; EP 2,846,465; HK 1,157,080; SA 2001/2151; SA 2006/05363; SA 2014/01541; SA 2017/02224;

AirButton®, Azoteq®, Crystal Driver®, IQ Switch®, ProxSense®, ProxFusion®, LightSense™, SwipeSwitch™, and the  logo are trademarks of Azoteq.

The information in this Datasheet is believed to be accurate at the time of publication. Azoteq uses reasonable effort to maintain the information up-to-date and accurate, but does not warrant the accuracy, completeness or reliability of the information contained herein. All content and information are provided on an "as is" basis only, without any representations or warranties, express or implied, of any kind, including representations about the suitability of these products or information for any purpose. Azoteq disclaims all warranties and conditions with regard to these products and information, including but not limited to all implied warranties and conditions of merchantability, fitness for a particular purpose, title and non-infringement of any third party intellectual property rights. Azoteq assumes no liability for any damages or injury arising from any use of the information or the product or caused by, without limitation, failure of performance, error, omission, interruption, defect, delay in operation or transmission, even if Azoteq has been advised of the possibility of such damages. The applications mentioned herein are used solely for the purpose of illustration and Azoteq makes no warranty or representation that such applications will be suitable without further modification, nor recommends the use of its products for application that may present a risk to human life due to malfunction or otherwise. Azoteq products are not authorized for use as critical components in life support devices or systems. No licenses to patents are granted, implicitly, express or implied, by estoppel or otherwise, under any intellectual property rights. In the event that any of the abovementioned limitations or exclusions does not apply, it is agreed that Azoteq's total liability for all losses, damages and causes of action (in contract, tort (including without limitation, negligence) or otherwise) will not exceed the amount already paid by the customer for the products. Azoteq reserves the right to alter its products, to make corrections, deletions, modifications, enhancements, improvements and other changes to the content and information, its products, programs and services at any time or to move or discontinue any contents, products, programs or services without prior notification. For the most up-to-date information and binding Terms and Conditions please refer to www.azoteq.com.

www.azoteq.com/ip

info@azoteq.com